

*INSTRUCTION MANUAL ON*

# **THE CABLE COMMANDER**

(MODEL A-7)  
CABLE LOCATOR

including instructions on the  
Inductive Coupler & Non-Metallic Pipe  
Locator, The Sewer & Mini-Snooper  
U.S. PATENT NO. 3,597,680

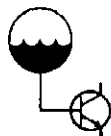
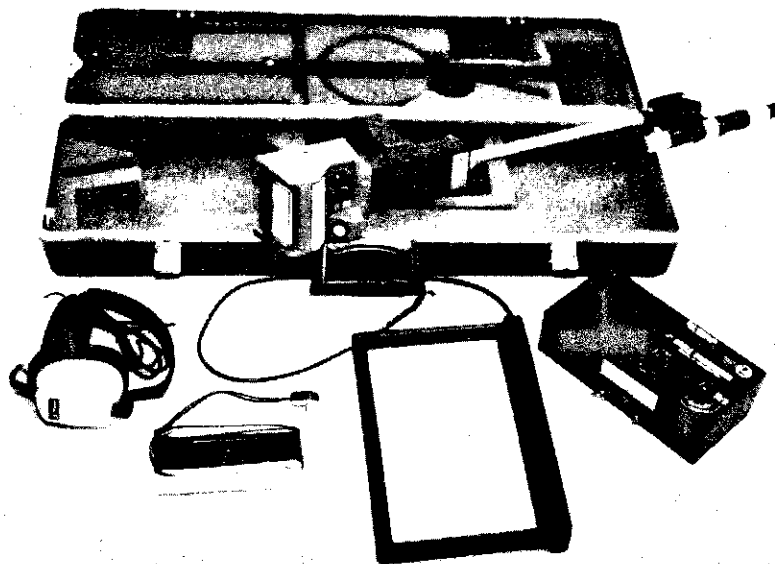

**AQUA-TRONICS, INC.**

1212 N.E. 5th Street • Redmond, OR 97756  
TEL (541) 548-2110 FAX (541) 548-2117

# INSTRUCTION MANUAL

## Table of Contents

	PAGE #
<b>I. DESCRIPTION</b>	
a. Accessories .....	1
1. Battery Test .....	1
<b>II. OPERATING INSTRUCTIONS</b>	
A. Direct Tracing .....	2
B. Locating by the NULL Method .....	3
C. Locating by the MAXIMUM Method .....	4
D. Inductive Tracing .....	5
E. Tracing with the Inductive Coupler .....	5
F. Correcting a Wide or Broad Peak Reading .....	6
G. Determining Depth .....	7
<b>III. OPERATING INSTRUCTIONS FOR SEWER SNOOPER OR MINI-SNOOPER</b> .....	8
<b>IV. SERVICE AND WARRANTY</b> .....	11

### I. DESCRIPTION

The Model A7 Cable Commander locator is designed for locating cables and pipes. It can be used to trace the exact route, position, and depth of a cable or pipe.

#### a. ACCESSORIES FOR THE MODEL A7 CABLE COMMANDER

The Model I.C. 49 or I.C. 56 Inductive Coupler is used to isolate a line from other utilities even though they are sharing a common ground. The Sewer Snooper or Mini-Snooper is used for locating non-metallic pipe and duct. These accessories are covered in this manual. See the Table of Contents for page number.

#### 1. BATTERY TEST

**RECEIVER:** The receiver must be turned on to test the battery. Signal being received by the receiver will work the receiver battery as it is worked in normal operation, thus, the transmitter should also be turned on and the receiver Sensitivity control turned up when testing the receiver battery. Push the Battery Test switch for a battery voltage indication on the meter. Any meter reading in the Batt. OK scale indicates a good battery. A meter reading below the Batt. OK scale indicates the battery is low and should be replaced with an Eveready #216 or 9 volt equivalent.

*Note:* A safety check of the receiver battery is built in if the loudspeaker is being used. If the receiver audio and meter pulsates when a very low sensitivity setting is used, and the receiver is picking up signal from the transmitter, replace the receiver battery. A battery test will indicate a low battery.

**TRANSMITTER:** Rotate the Power control from the Off position to any Power setting. Rotate the function control to Battery Test. The small light on the face of the transmitter indicates a good battery if the light is on. A bright light indicates a fresh battery. A dim light indicates the battery is getting weak and should be checked more often. If the light fails to light, the battery is low and should be replaced with an Eveready #276 or 9 volt equivalent.

## II. OPERATING INSTRUCTIONS

### A. DIRECT TRACING

The transmitter is attached directly to an exposed portion of the line to be traced. Use the cable clamp and the ground plate supplied with the instrument. Be sure the cable clamp is attached to clean bare metal. For maximum tracing range, the ground plate should be as far away from the transmitter as possible and at right angles to the direction of the pipe or cable. Most locations can be made by placing the ground plate near the transmitter.

Connect the cable clamp and ground plate leads to the transmitter. If possible, push the ground plate into the ground for a good earth connection. Pouring a bucket of water on the ground will also help insure good earth connection for the ground plate in sand, dry soil, or on concrete if soil is not available. Switch the transmitter function switch to any one of the five Direct Output positions. Turn on the transmitter to a low power setting. For greater tracing range and deep locations, a higher power level may be required, but most locations can be made with the Power control just barely on.

With the transmitter connected and operating, turn on the receiver and set it down near the transmitter where the meter can be observed. Adjust the receiver Sensitivity control for a mid-scale reading. Adjust the transmitter through the 5 Direct Output positions and select the tap that gives the highest meter reading on the receiver. The Sensitivity control may have to be readjusted at some tap positions to observe the maximum meter indications. When the tap switch is at the position where the highest reading on the meter is obtained, the Direct Output is most closely matched to the cable or pipe being energized. The receiver can now be used to trace the position and depth of the line being energized. See Fig. 1, 2, and 3.

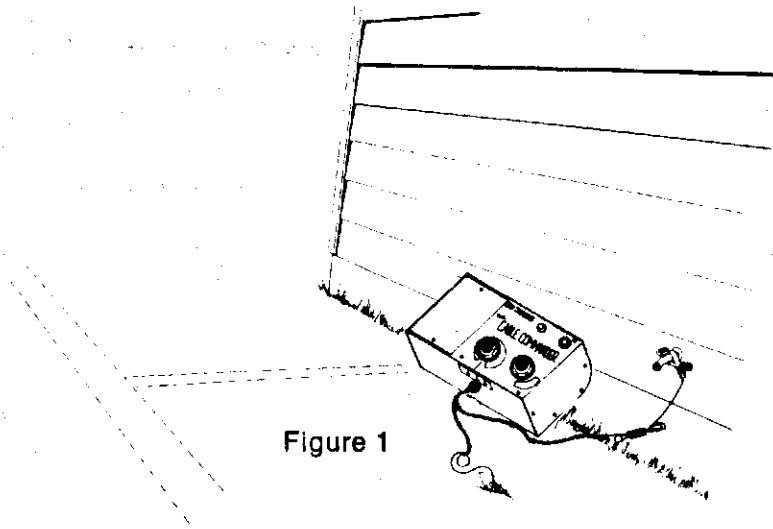

Figure 1

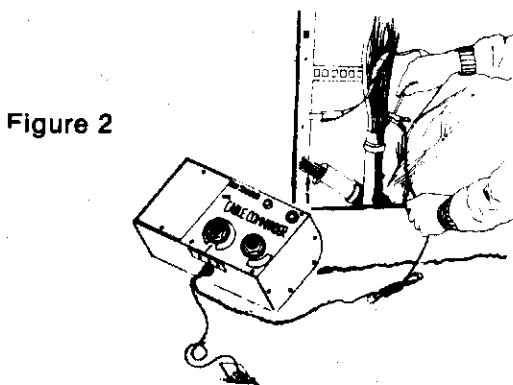

Figure 2

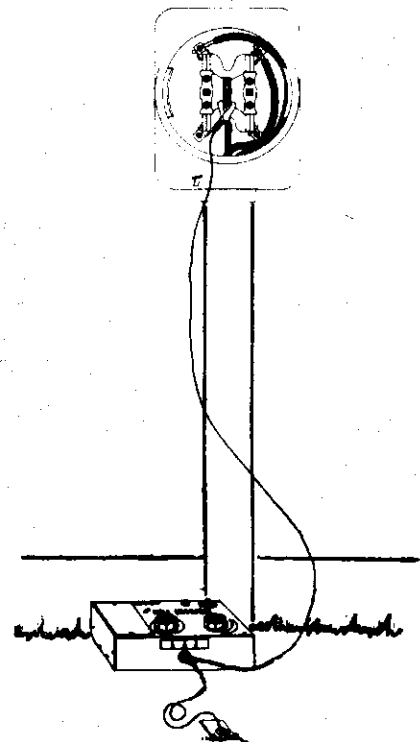

Figure 3

**NULL** — See Fig. 4. With the antenna vertical to the ground (parallel to the extension arm), the meter reading will increase as the antenna approaches the cable. Directly over the cable, a loss of signal will be found and the meter will decrease to a zero or minimum level. The signal will return to a high level and then start falling off as the antenna leaves the exact center of the cable. On both sides of the cable, a high meter reading is available, but a loss of signal occurs when the antenna is directly over the cable.

**B. NULL METHOD:**

With the receiving antenna moved to the vertical position (see Fig. 4), adjust the Sensitivity control for an on-scale meter reading. Walk in the direction the meter reading increases. As the antenna crosses the cable, the meter will fall to some lower reading and then will return to a higher level on the other side of the cable. The center of the cable will be directly below the null or minimum meter reading.

The cable will be directly below the center of the null. The Sensitivity control will determine how sharp or how broad the null will be. The operator cannot see the lowest reading if the meter is below a "0" reading. If the null is broad, increase the sensitivity control until a sharp null is found. If the null is so sharp that the meter does not have time to respond, the operator could walk over the cable and not see a null; however, he might hear a small loss of tone. The sensitivity should be reduced to the point where a sharp null can be found.

The cable can now be traced by finding two (2) null points. This will give the operator the direction of the cable run at that point. By walking in the direction to be traced, move the instrument (receiving antenna) from side to side, keeping the receiving antenna vertical to the ground at all times (do not swing the antenna from side to side). A higher meter reading will be found on each side of the cable with a null occurring directly over the center of the cable.

Signal being radiated from a single pipe or cable will be round and the null will be easy to find. If more than one utility is in the same trench, or area, the signal being radiated from each utility can add together producing a distorted field. This distorted field can wash out a null to a point where the receiver cannot produce a distinct null. If the null cannot be found, go to the maximum method of locating.

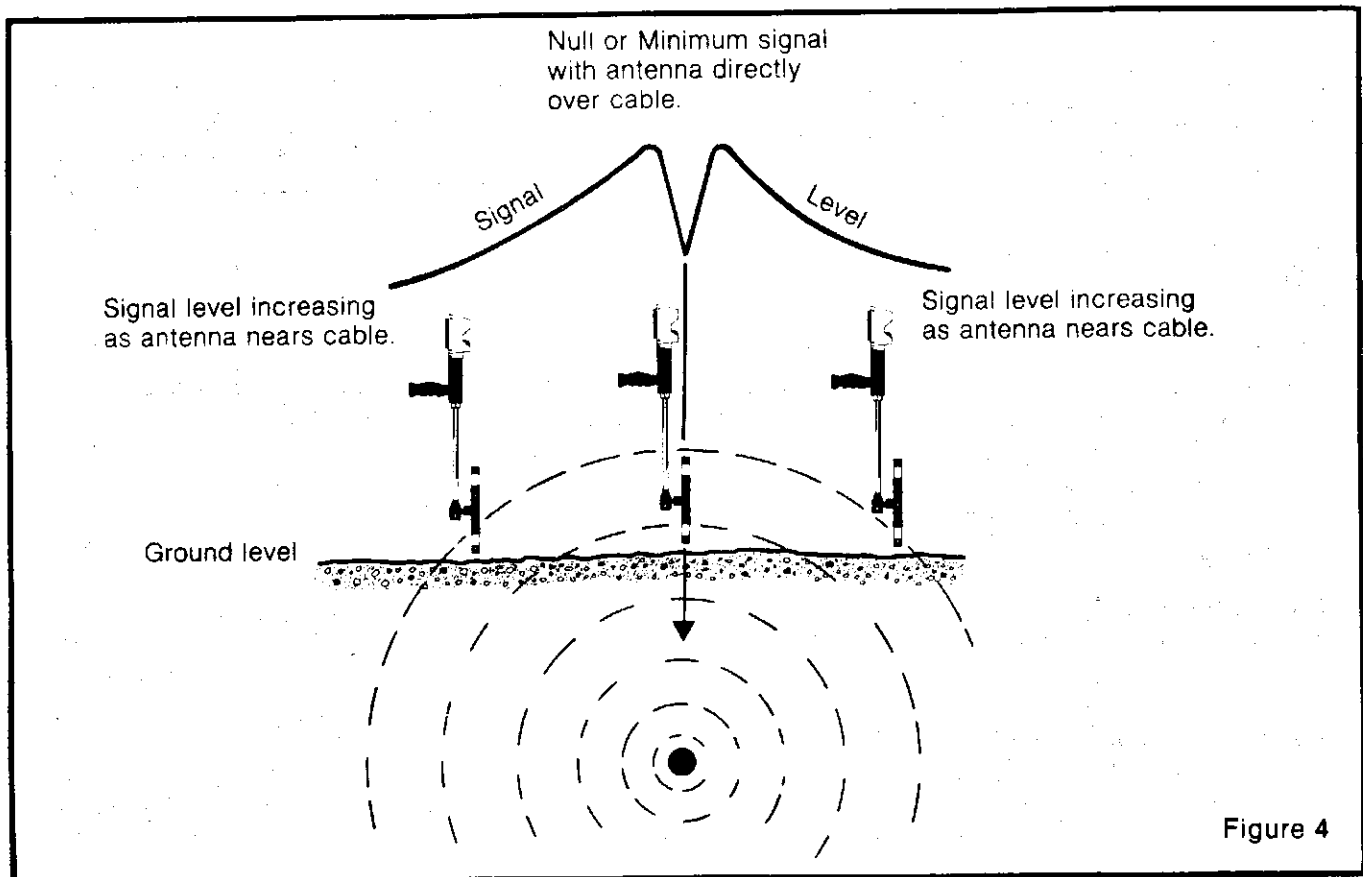

Figure 4

**MAXIMUM OR PEAK** — See Fig. 5. A maximum meter reading will be found directly over the cable and the meter will decrease to lesser readings as the instrument moves away from either side of the cable location.

**C. MAXIMUM METHOD:**

With the receiving antenna in the horizontal position and close to the ground (see Fig. 5), use the Sensitivity control and set the meter to some on-scale reading. Walk in the direction that increases the meter reading. The meter reading will increase as you near the cable. If the meter goes off-scale (above 10), reduce the Sensitivity control to an on-scale reading again (the operator cannot see a maximum meter reading if the meter is off-scale). By keeping the meter reading on scale as the operator walks in the direction the meter reading is increasing, a maximum meter indication will be found as the operator crosses the cable. As the operator continues past the cable, the meter reading will start decreasing. Hold the receiving antenna directly over the maximum or peak reading and slowly rotate the instrument until a new peak reading is found. When the antenna is directly over and at right angles ( $90^\circ$ ) to the direction of the cable path, the highest reading will be found. The cable will be directly below the center of the antenna.

Now that the cable has been located, the cable path can easily be traced. With the antenna directly over and at right angles to the cable path, walk in the direction to be traced. Keep moving the instrument from one side of a maximum reading to the other. Each time a maximum reading is found, the cable will be directly below the receiving antenna. Do not swing the antenna from side to side.

When the cable has been found and the exact position is needed, turn down the Sensitivity control until a very small movement of the meter can be seen as the antenna passes over the cable (the lowest reading the operator can detect on the meter). This will help insure that other cables in the area are not influencing the location.

*Note:* If you obtain a wide or broad peak reading from the receiver when locating your cable near the transmitter, see item F, page 6.

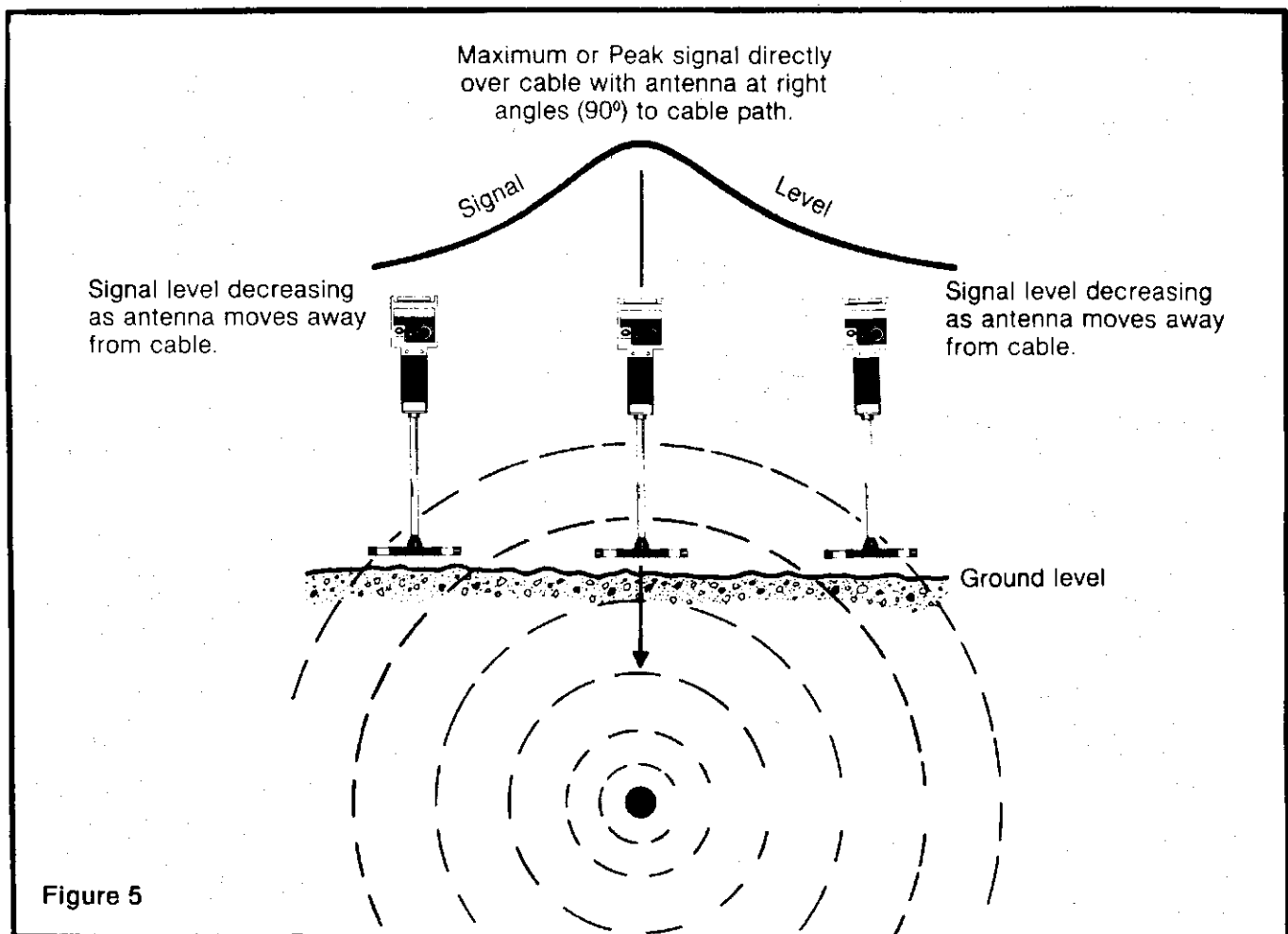

#### D. INDUCTIVE TRACING

Set the transmitter directly over and in-line with the pipe or cable to be traced. The function control should be switched to Inductive. Turn the transmitter on to the lowest power setting possible. More power can be used if needed, but low power will help reduce signal being applied to other utilities that may be in the same area. See Fig. 6.

When the transmitter is set to Inductive, the receiver can also pick up the transmitter if you are close to it. On low power, the receiver should be at least 20 feet away from the transmitter before a location is made. If a higher power is used, move farther away. On high power you should be at least 50 feet from the transmitter. The receiver is used in either the null or peak method to trace your line. See Fig. 4, and 5.

Signal being radiated from the transmitter antenna not only penetrates the ground, but also permeates the air around the transmitter. The strongest signal will be found along the axis that is in-line with the transmitter case. If you have doubt as to having located a pipe or cable, or the transmitter itself, off-set the transmitter about 10 degrees off the route of the line being energized. If you still locate a line in the same position as before, you have a good location. If you cannot locate the line in the same area, check to see if you are now locating a new line that is in line with the transmitter case. If you do find this new location, you are too close to the transmitter and no line exists in that area.

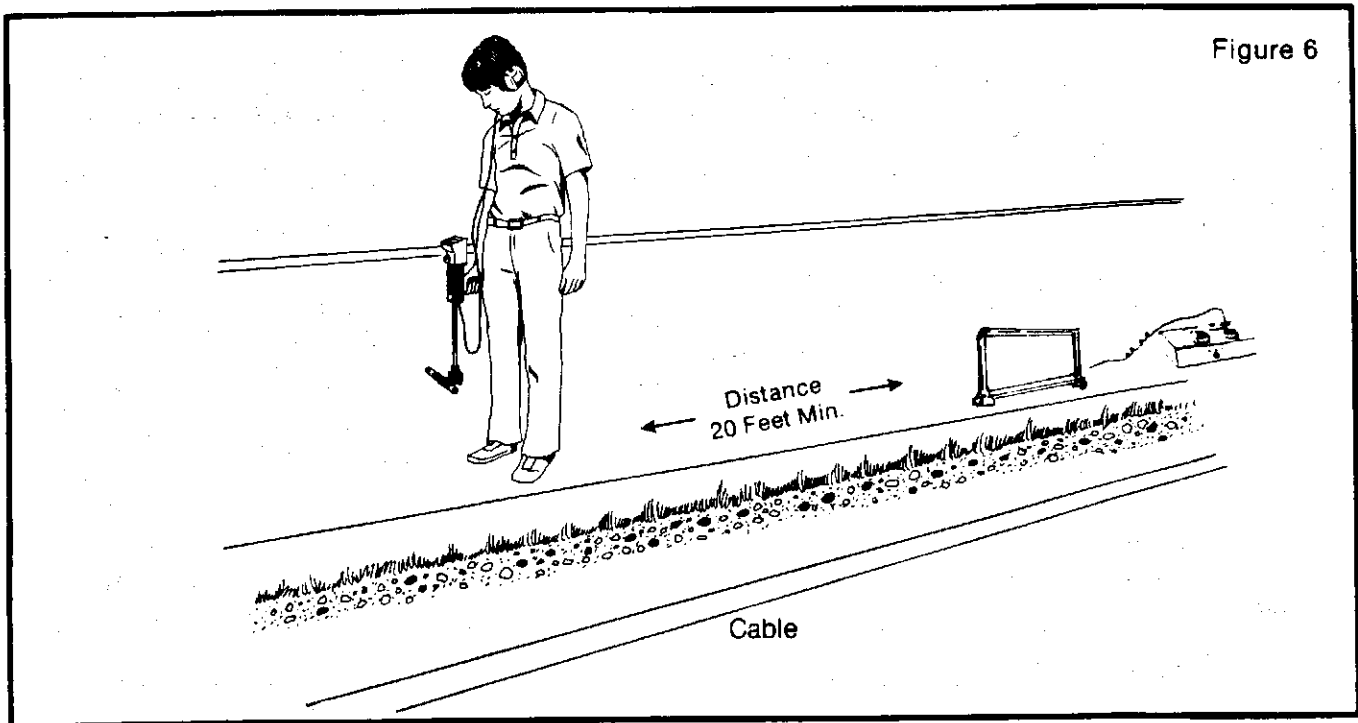

#### E. TRACING WITH THE INDUCTIVE COUPLER

The only situation when the coupler should not be used is at a terminated end of a line. (Test caps, water faucets, dead end of a pipe or cable.) A limited performance will be obtained unless there is some length of conductor on both sides of the coupler.

A gas meter has an insulating gasket that insulates the house pipe from the incoming line. When coupling to a gas meter, this will be the end of pipe unless a jumper wire is used to bypass the insulating gasket. Connect a jumper wire from the shut-off valve (bare metal) to one of the screwheads on the face of the meter. A good trace can be made if the meter gasket is bypassed. See Fig. 7.

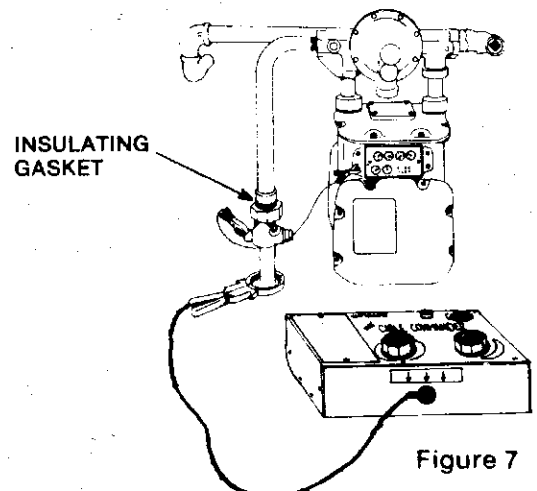

Connect the coupler terminals to the direct output terminals of the transmitter. Set the function tap switch to tap #2. This will set the impedance of the transmitter to the impedance of the coupler. Turn on the transmitter to low power and proceed with your location. The receiver can be used in the null or maximum method.

If you are obtaining wide peak readings, see item F, on this page.

The coupler can be placed around metallic or non-metallic ducts providing a metal conductor of some type is inside the non-metallic duct.

On telephone cables, always clamp around the cable below the sheath bond. This will induce the tone on the sheath. The coupler can be placed around a telephone service drop without removing the house protector cover. The 117.85 KHz tone is well above the audio hearing range and will not noise up a working cable. See Fig. 8, and 9.

A light-weight machine oil should be applied to the hinge area several times a year.

The mating parts of the core material should be free of dirt or contamination at all times. Some tracing range can be obtained if the coupler is not closed, but maximum tracing will require the coupler to be completely closed.

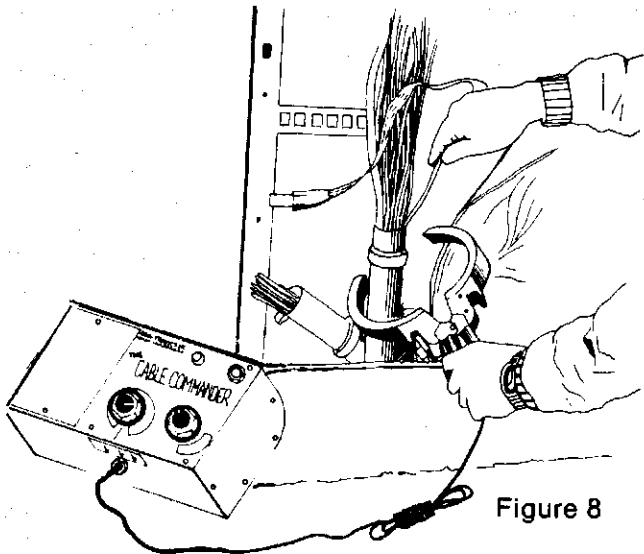

Figure 8

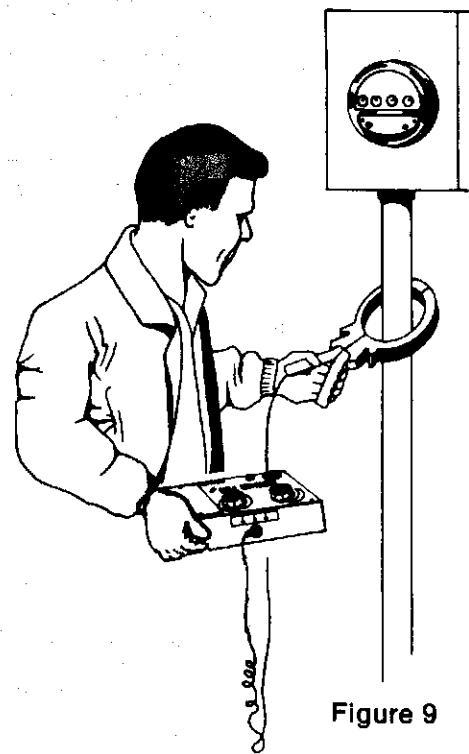

Figure 9

#### F. CORRECTING A WIDE OR BROAD PEAK READING

When using the Inductive Coupler or the Direct Output mode of tracing, there may be times when a wide or broad peak reading is found. Even on low power, the transmitter is placing too much signal on the line being traced and this is flooding the receiver.

Reducing the amount of signal the transmitter is placing on the line can be accomplished by mismatching the Direct Output of the transmitter. If the Inductive Coupler is being used, switch the output tap switch to tap #5. If a conductive trace is being used, switch that tap switch to one of the five positions that is farthest away from the correct tap number. This will reduce the signal level being placed on the line and a sharp peak reading can be found.

Always start your trace by setting up the tap switch to the correct tap number because it will provide the most range and depth. Only mismatch the tap switch when the broad or wide peak reading is present on a given location.

## G. DETERMINING DEPTH

The null or maximum method will locate the depth of an energized cable. While this manual only explains the null method, the maximum method can be used if the operator positions the receiving antenna for a maximum signal at 45°.

On a 45° triangle, two of the three sides will always be equal. The true 45° angle for the null method will be when the bubble is centered or shows level on the depth gauge.

The receiving antenna should be adjusted to the vertical position for a null reading. After the cable has been located and its exact position marked, the receiver should be tilted to a 45° angle with the antenna close to the ground. With the operator facing the cable and off to one side, move away from the cable at a right angle, see Fig. 10. When the receiving antenna is again pointing at the cable, a new null will be found. Mark this depth null on the ground. Measure the distance between the depth mark and the cable position mark. The distance between these two marks will be the depth of the cable.

The Sensitivity control may have to be adjusted while making a depth reading. The null found should be sharp enough to pinpoint the spot you want marked. Also, bear in mind that the distance is calculated at a 45° angle from the receiving antenna. The calculations will have to take into account any slope of the terrain, or the height that the receiving antenna was held above the ground when making the depth measurement.

When possible, a depth reading should be made from both sides of the cable. If both depth measurements agree with each other, the operator can assume a good depth measurement has been made. If the two depth readings do not agree with each other, the operator should again locate the position of the cable and then repeat the two depth measurements. If the two readings still are not the same, care should be used when digging up the cable. Other cables in the area, or other utilities that have signal on them could be distorting the field being radiated from the cable under location. If this distortion is present, the located position and depth could be off.

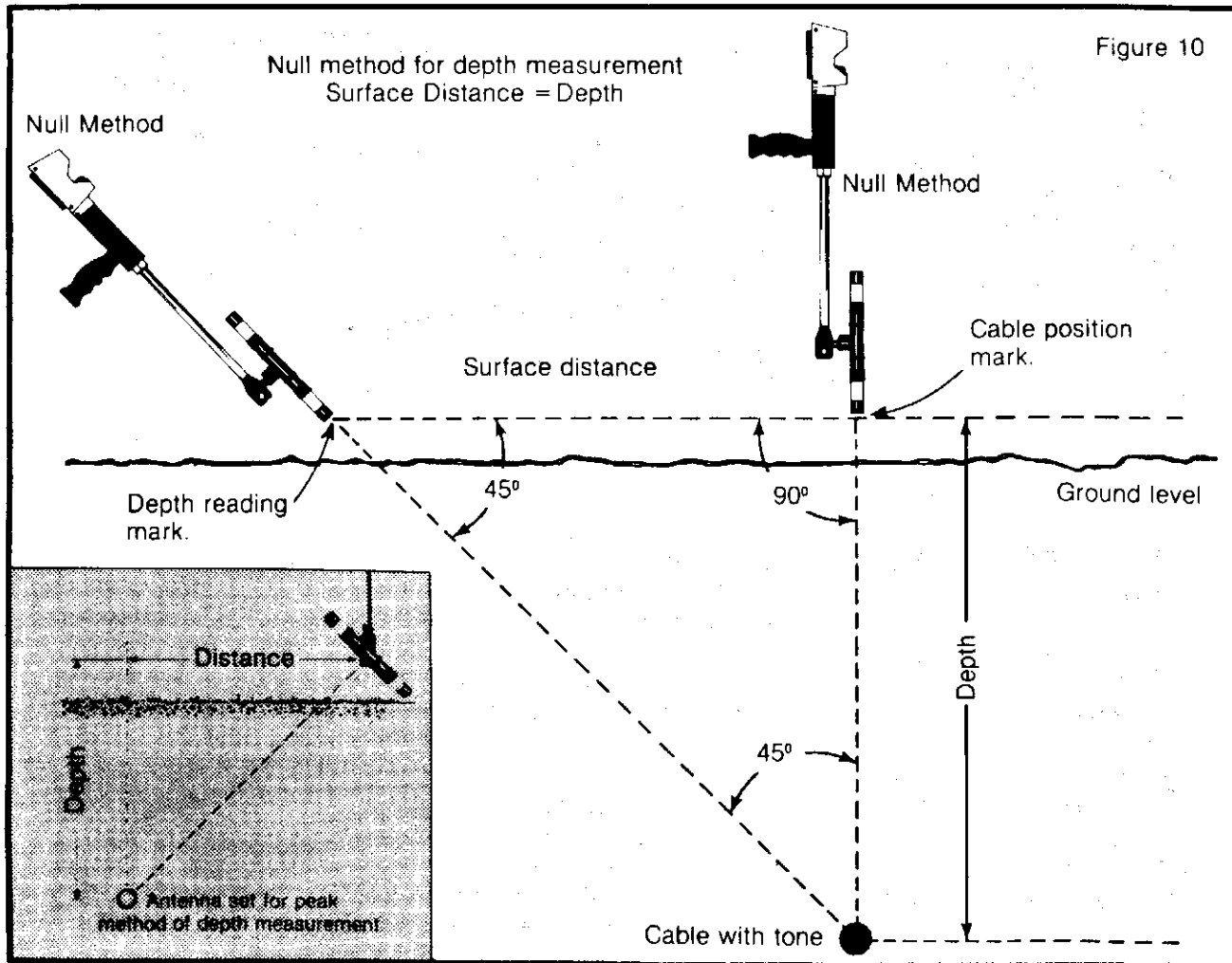

### III. OPERATING INSTRUCTIONS FOR SEWER SNOOPER OR MINI-SNOOPER

1. The Sewer Snooper and Mini-Snooper are used for Non-Metallic pipe or duct location. The Snooper is a small radio transmitter that will attach to a conventional rodding machine or sewer tape. It is forced through the pipe or duct while the Model A7 receiver is used to accurately trace its position and depth. This method of locating non-metallic lines is far more effective than energizing a metal tape.

**The Sewer Snooper:** 2" dia. x 6½" long and can be located up to 50' deep. It will negotiate a 4" clean-out and should be used in 4" dia. pipes and larger.

**The Mini-Snooper:** 1½" dia. x 4" long and can be located up to 25' deep. It will negotiate a 90° bend in a 3" pipe if connected to a flexible leader of some type.

Sewer Snooper Battery — Eveready #216 or 9 volt equivalent.

Mini-Snooper Battery — Eveready #544 or Mallory PX-28B Silver Oxide 6 volt or equivalent. This battery can be found in most stores selling Canon or Nikon photo flash equipment.

A new battery will provide about four (4) hours of continuous operation. A new battery should be used when locating a line near the maximum depth limitations of the Snooper being used.

#### 2. Familiarization

Before trying to locate a pipe underground, be sure to familiarize yourself with the basic operation of the transmitter and receiver. The following procedure simulates actual operating conditions, and should be useful as a guide.

##### A. Operating Tests

Turn the Snooper transmitter ON and place it on the ground where it can be seen. Turn the receiver ON and adjust the receiver Sensitivity control until a mid-scale reading is obtained on the meter.

Walk away from the transmitter, and note that the meter indication and audio signal will start to decrease. Conversely, when walking toward the transmitter, the signal will increase. This simple operation can be very useful in finding the approximate location of the transmitter underground.

A procedure to locate the transmitter precisely is described as follows:

**Step 1.** With the receiving antenna moved to the vertical position, see Fig. a, walk in a large circle around the transmitter which was placed on the ground. Adjust the receiver Sensitivity control for a mid-scale reading on the meter.

**Step 2.** Notice that when the receiver is moved past a point exactly at a right angle to the transmitter, the meter will drop to zero, then quickly move back up-scale. As the meter goes to zero the audio signal will also decrease. This sudden drop in signal will be referred to as a "NULL" throughout the rest of the manual. Move the receiver back to the point where the null was obtained.

**Step 3.** Try increasing the Sensitivity control, and repeat Step 2. Notice that as the sensitivity is increased the null becomes very sharp. However, if the sensitivity is set too high you may pass through the null point without seeing any indication, because the meter will not respond fast enough. Increase the Sensitivity control only enough to get a sharp null, then mark a spot on the ground directly below the antenna.

**Step 4.** Adjust the Sensitivity control until the meter reads in the upper half of the scale. Continue walking around the transmitter until a second null point is found on the opposite side of the transmitter. Increase the sensitivity for a sharp null, then mark the spot on the ground. Note that a line connecting these two null points would pass through the transmitter. (See Fig. a.) No matter how many circles are made, or the diameter of the circles, all of the null points will line up with each other. An imaginary line drawn through all of the *null* points will cross the transmitter at a right angle to the direction in which the transmitter is pointing. (The receiver must be held as shown in Fig. a.)

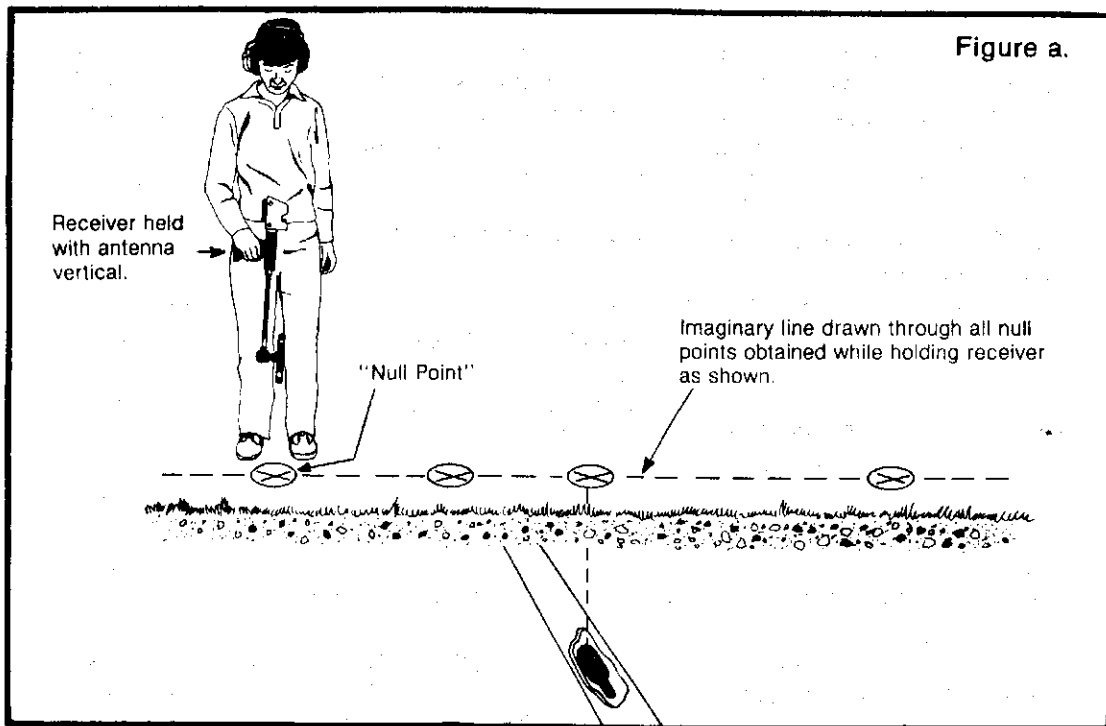

**Step 5.** See Fig. b. Hold the receiver with the receiving antenna horizontal to the ground and parallel to the imaginary line found in Fig. a, but keep about 5 feet away from it. At some point a null will be obtained. Increase the sensitivity for a sharp null, and mark this spot on the ground as shown in Fig. b. Keep the antenna horizontal with the ground and parallel to the imaginary line, as shown in Fig. b, as you walk. Continue on a short distance, then move to a point about 5 feet on the other side of the imaginary line. Walk a parallel line in the opposite direction. Again mark the *null* point. Now, if another imaginary line is drawn between the two *null* points found in this step, the point where the two lines cross should be the exact location of the Snooper transmitter.

**Note:** A good proficiency check is to have someone hide the transmitter for you to locate. Don't panic! Go back to Steps 1 through 5, and you will not only locate the transmitter, but the direction of its axis can also be determined.

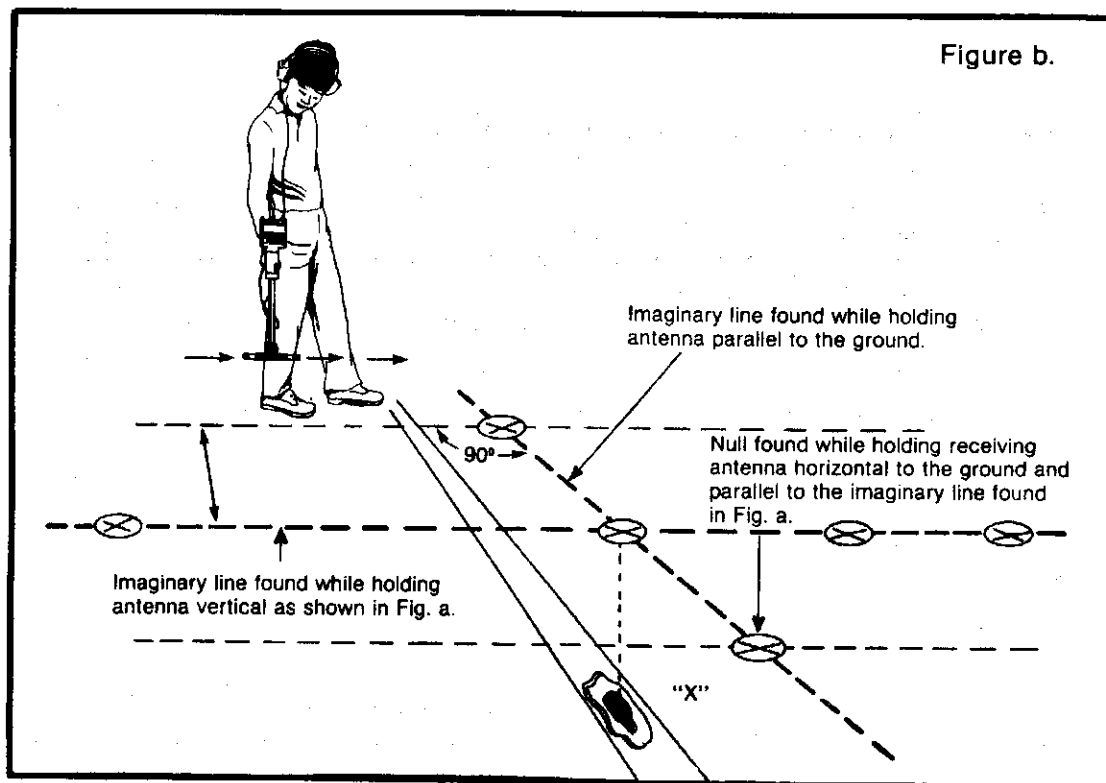

## B. Summary of Preceding Steps

1. Hold the receiving antenna vertical. Walk in a circle (or the direction in which the signal increases) until a null is found.
2. Increase the sensitivity and mark the null spot. See Fig. a.
3. Continue around the circle until the second null is found and mark this spot. Connect the two null spots with an imaginary line.
4. Hold the receiving antenna horizontal to the ground and parallel to the imaginary line found in Fig. a. See Fig. b. Walk 5 feet away from the imaginary line, but parallel to it and locate the *null* on both sides of the imaginary line and mark these two spots. Connect them with an imaginary line.
5. "X" marks the location of the transmitter.

*Note:* Both null points found in Steps 1, 2 & 3 could be on the same side of the transmitter. Keep walking during Step 4 until a null is found. The imaginary line from Steps 1, 2 & 3 is a straight line as shown in Fig. b.

## 3. Locating a Non-Metallic Pipe

### A. Connecting Transmitter to Rodding Machine

Remove the end cap from the Snooper, and attach this cap to the rodding machine, snake, or tape. Turn on the transmitter and listen for the tone in the receiver. Screw the transmitter back onto the end cap, and make sure it is on tight. Inject the transmitter into the pipe.

*Note:* The Snooper will *not* broadcast its whereabouts inside a metallic pipe. A sudden loss of signal may indicate the transmitter has entered a metallic pipe that connects to the non-metallic line. There will be a tone change as it nears the metal pipe, and then all tone will disappear as it enters the metal pipe.

### B. Adjustment of Rodding Machine Clutch

The Snooper is rugged, but not indestructible. Care should be used when fastened to a rodding machine, snake, or tape. On large rodding machines, the clutch should be adjusted so that any obstruction will make the rodding machine slip, and use only enough clutch tension to insert the transmitter. Another precaution is to avoid spinning the rod, if possible. In a large pipe, spinning the rod will cause the transmitter to whip against the sides of the pipe. The Snooper cannot be treated like a root saw, or an auger, but with a little care it will last for a long time.

## 4. Locating Metal Inside a Non-Metallic Pipe

This ability can be demonstrated by turning on the Snooper transmitter and receiver and placing the Snooper near a metal object. Notice that a change in pitch of the sound in the receiver will take place when the Snooper is brought close to the metal. The Snooper may not detect a large piece of metal outside of a non-metallic pipe, but it will respond to a very small metallic object inside the pipe. This feature of the Snooper is very useful in locating such items as a root saw, or a broken tool of some type in the pipe; also it can be used to determine whether an obstruction is caused by a metallic object. Most types of metal will make the tone increase in pitch; however, some types of metal make the tone decrease in pitch. When searching for a specific metal object, such as a root saw, or a broken tool of some type, try holding the Snooper near a like object. Listen for the change in pitch of the tone — this tone change may help in identifying the object in the pipe.

## 5. Determining Depth of the Snooper

Once the location of the transmitter is precisely determined, hold the receiver antenna at 45° as shown in Fig. c, and move away from the imaginary line found in Fig. b. When you find a null in this position, mark this null spot on the ground. The distance from this *null* point to the spot marked in Fig. b, is equal to the depth of the transmitter below the spot marked "X." (Note that this depth is to the transmitter rather than the center of the pipe.) When working on a steep or rough ground, bear in mind that the distance is calculated at a 45° angle from the receiver case. The calculations will have to take into account any slope of the terrain, or the height that the receiver was held above the ground when making the depth measurement.

*Note:* If trouble is encountered in finding a *null* with the receiving antenna held at 45°, go back and carefully check the four *null* points in Steps 1 through 5.

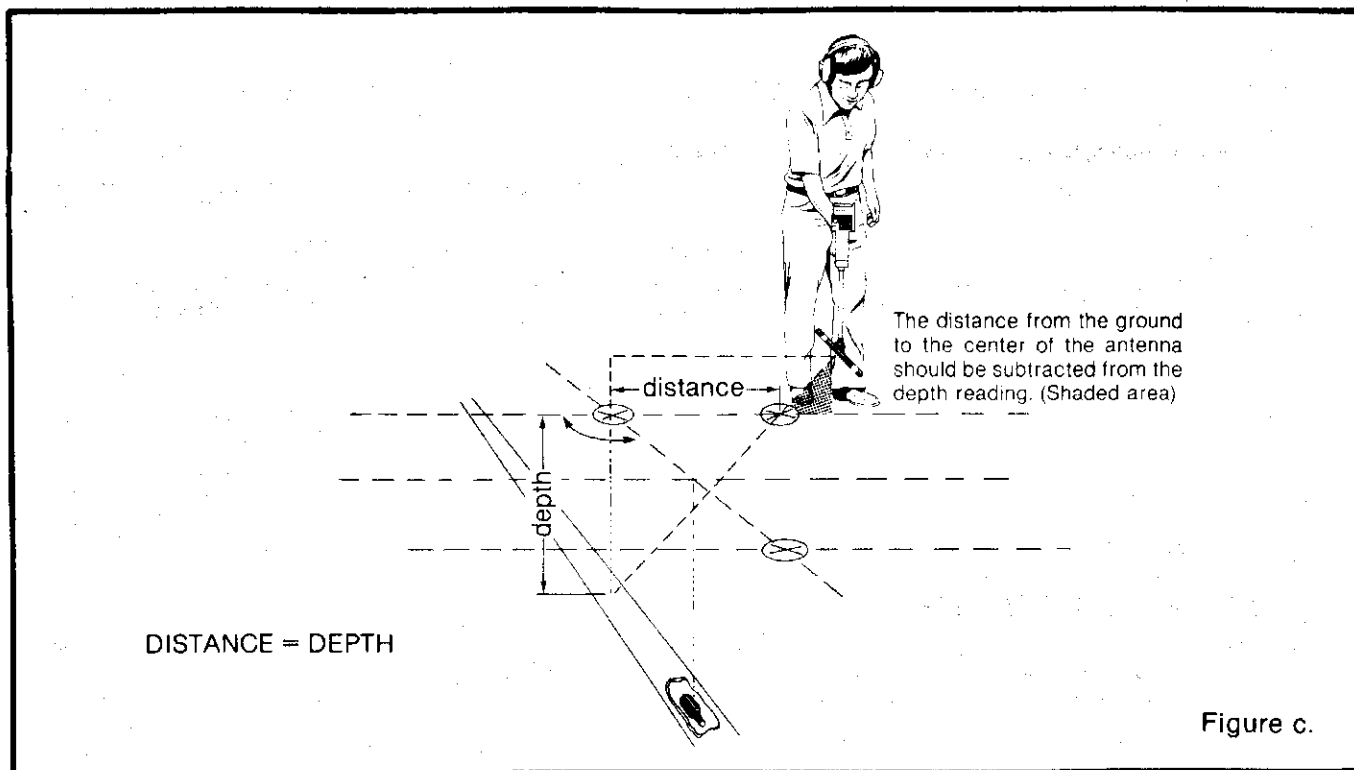

#### 6. Tuning the Sewer Snoopers or Mini-Snooper to Your Receiver

Turn on the receiver and Snooper. Turn the Sensitivity control to #5 on the dial.

Use a small screwdriver and adjust the small screw inside the Snooper in the direction that the tone or pitch DECREASES. Adjust the screw until the tone in receiver decreases to a point where you have no tone coming from the receiver. At this point, an adjustment in either the counter-clockwise or clockwise direction of the small screw will bring the tone back. From this no-tone position, adjust the screw in the counter-clockwise direction until you have a good rich audio tone in the receiver. Hold a watch or piece of aluminum near the antenna section of the Snooper. If the tone increases when the metal is near the antenna, the Snooper is tuned and is ready for use. If the tone decreases as the metal is placed near the Snooper antenna, start over. You did not adjust counter-clockwise from the no-tone position.

### IV. SERVICE AND WARRANTY

#### Instrument Service

If for any reason you have trouble, or require assistance with your instruments, contact the nearest Aqua-Tronics sales outlet. You may, if you so desire, write or call directly to Aqua-Tronics, Inc. manufacturing plant and give full details of your problem, or needs.

#### Warranty

All Aqua-Tronics products are warranted against defective materials and workmanship.

The Model A7 Cable Commander, Inductive Coupler, Sewer Snoopers and Mini-Snooper have a one-year warranty from date of purchase.

Aqua-Tronics will repair or replace all products which prove to be defective during the warranty period. All repair will take place at our manufacturing plant or one of our field Service Centers. The decision of determining warranty defects from abuse or breakage, and where the instrument is to be repaired, lies with Aqua-Tronics, Inc.

If you send your instrument in for factory service, please send it pre-paid. If the service is covered under warranty the instrument will be returned pre-paid. If the instrument is not covered by warranty the instrument will be sent to you C.O.D.